

# Control Technologies Utilized in the UPS

Satoru Shimizu Muneo Suita

## 1. Introduction

The AC uninterruptible power supply (hereafter, UPS) that is supporting stable operation of the telecommunications system is becoming more and more important as these systems advance.

In the past, the UPS used to be a “Rotating Type” which was made up from a motor, a generator, an engine, and a flywheel etc., but it has shifted to a “Static type” which is the combination of a power converter with battery power. Users need improvements in the performance, the effectiveness, and the reliability. At the same time, various methods have been developed to pursue compact-size, lower weight, and reasonable price while meeting all application requirements.

This document introduces the typical methods and the control technology of the UPS.

## 2. Method and Control of Uninterruptible Power Supply

### 2.1 Continuous Inverter Power Supply System Method

The structure of this UPS is as shown in Fig.1. This UPS usually converts commercial power into direct current and re-converts into stable alternating current with the DC/AC converter while supplying power to the load. When commercial power fails, the DC/AC converter is activated with the battery connected on the direct current side.

The distinctive characteristic is to continuously obtain the constant voltage output completely without power failure when commercial power fails or changes. Moreover, if the load current exceeds ratings of the converter or the converter breaks or is in need of maintenance, the by-pass switch is provided to directly supply commercial power to the load. At this time, the synchronous tracking control that connects the converter output to the commercial voltage waveform and the switching control for the by-pass switch are instructed to switch the converter output and the by-pass is without momentary power outage.

This method represents the high performance UPS, which our company have been developing in small to large capacity systems.

### 2.2 Off-Line UPS System Method

The structure of this UPS is as shown in Fig.2. This UPS usually supplies commercial power to the load through the by-pass switch, and the DC/AC converter output is powered by battery when commercial power fails. The distinctive characteristics of this UPS are high driving efficiency and energy saving, since the commercial power is usually connected to the load without going through the converter, which results in no power loss unlike the continuous inverter power supply system.

However, the momentary power break of the output occurs when switching to the DC/AC converter after the business power failure is detected. Length of the break depends on if it's in the “hot standby” (standby with converter running) or the “cold standby” (standby without running the converter), or whether the switch is a high-speed semiconductor or the electromagnetic mechanical switch, and the detection speed of the power failure circuit.

The instantaneous detection, which compares each instantaneous value of the commercial power waveform (sine wave) and the limit value setpoint, is used for high-speed detection, but a power break up to a few milliseconds is unavoidable. Therefore, this kind of UPS is limited to equipment that works even with a momentary power break.

### 2.3 Parallel Processing Method

The structure of this UPS is as shown in Fig.3. In this UPS, the DC/AC converter in the structure of the continuous commercial power supply is changed to a bi-directional converter (refer to 3.3) and it also serves as a charger. The distinctive characteristic is that the bi-directional converter can operate not only as a charger but also as an active filter to absorb any ineffectiveness of the load current as well as high spikes. Momentary power break is similar to the continuous commercial power supply, however, we have achieved nearly no power breaks on the mid-range series by adding our original improvement (details are introduced in another document).

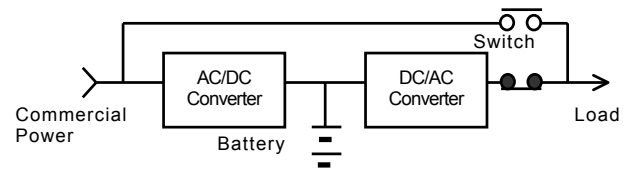

Fig.1 Structure of Continuous Inverter Power Supply

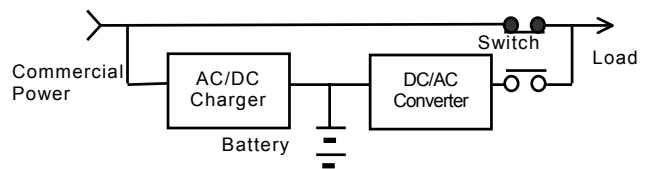

Fig.2 Structure of Off-Line UPS

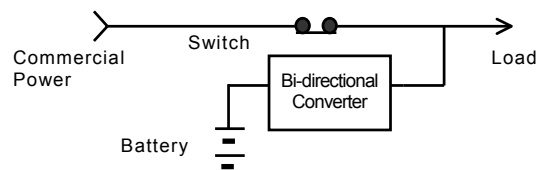

Fig.3 Structure of Parallel Processing

### 3. Structure and Control of the Power Converter

#### 3.1 Inversion Converter

The inverter circuit that converts DC into AC creates AC voltage (square wave) by switching the main semiconductor (generally IGBT and MOSFET) composed in the bridge shape. In addition, installing the AC filter that changes this voltage to a sine wave is the general structure of the inversion converter (Fig.4).

The output voltage of the inverter contains harmonics because it is a square wave with constant height, however, the AC filter can reduce the harmonic content with the resulting waveform more like a sine wave.

One of the ways to do this is to utilize a multiple inverter method that connects two or more inverters, and by shifting the switching points at the output terminal. The resulting voltage is the step wave as shown in Fig.5 and the low-level harmonics are reduced. As the number of steps are increased by adding more inverters, the waveform increases the sine wave shape. However, this method is limited to special large-scale machines since the control is not good due to so many inverter main circuits.

The PWM (pulse width modulation) control method is commonly used today. Using PWM technology, the area of the pulses is made to closely resemble the sine wave and low frequency harmonics are excluded by dividing the desired sine wave into many sections. The width of each pulse is in proportion to the height of the sine wave amplitude as shown in Fig.6. This voltage can be obtained by generating the pulses from the intersection of a sawtooth wave and the control signal of the sine wave.

Although the number of pulses increases and the voltage becomes closer to the sine wave if the frequency of the signal is raised, power loss occurs in the inverter with every pulse. A trade-off must be made concerning audible noise, filter design, harmonic content, and switching frequency.

Moreover, the instantaneously controlled output of the constant voltage is obtained when detecting the output voltage and creating the control signal out of the difference of voltage with the standard wave (separately made semi-sine wave signal), since the level of the output voltage is proportional to that of the control signal. In addition, we are aiming at space-saving and quality improvement by shifting to digital control using a microcomputer and DSP. There are a wide range of controls including the above-mentioned synchronous tracking control of the commercial power supply and the over current control.

#### 3.2 Forward Direction Converter

The high power factor converter (PFC) circuit is generally used due to the improvement of AC input power factor, current with reduced harmonic content, and stable DC output voltage. However, the full wave rectifier with a diode bridge is the simplest means to the forward direction conversion of AC to DC.

A typical basic circuit, single switching boost chopper type that is often used in small capacity UPC is shown in Fig.7, and the full bridge type that can be developed for three-phase is shown in Fig.8. Referring to Fig.7, AC voltage

is fixed at the semiconductor switch Q through the rectifier Rf and the reactor L. The energy accumulated in L outputs to direct current through the diode D when the circuit is opened. Semiconductor Q switches at high frequency just like the PWM inverter and is controlled so that the input current becomes a sine wave and the direct current voltage becomes constant.

In Fig.8, the same boost chopper operation as Fig.7 is shown with PWM switching used to control the Q1-4 of the bridge circuit (the semiconductor switch and the reverse parallel diode) individually.

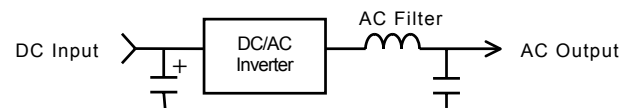

Fig.4 Structure of Inversion Converter

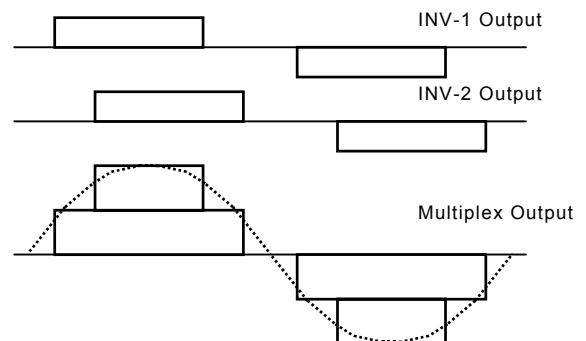

Fig.5 Multiple Inverter Waveform

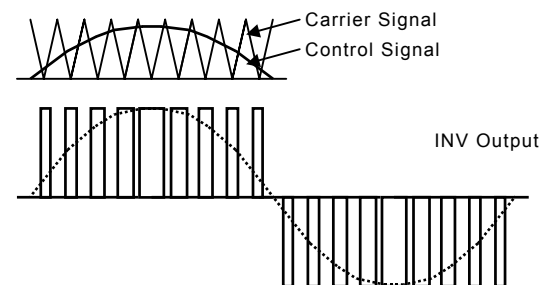

Fig.6 PWM Inverter Waveform

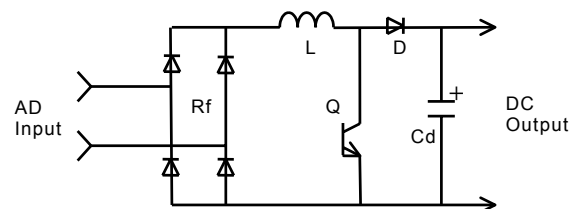

Fig.7 Single Switching Boost Chopper Type Forward Direction

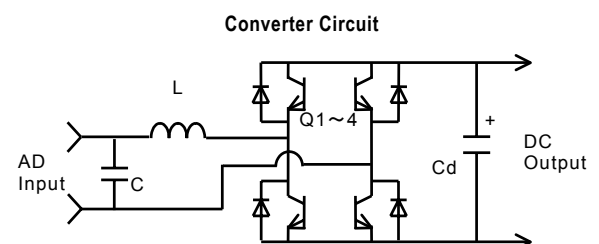

Fig.8 Full Bridge Type Forward Direction Converter Circuit

### 3.3 Bi-direction Converter

The forward direction converter circuit of the full bridge type in the preceding section (Fig.8) has the same structure (semiconductor bridge + reactor + capacitor) as the inversion converter (Fig.5) when considering the DC side as input, and the input and output are reversible. Therefore, it can be a bi-direction converter used as both a forward direction converter and an inversion converter by switching the control mode (forward direction converter=control AC current and DC voltage, inversion converter=control AC voltage). We are using this control technology for UPS (2.3 and 4.2).

Besides this, there are converters of a high frequency link method and a semiconductor insulation converter method, which are used for isolating between the outputs and input, but they will not be discussed in this document.

## 4. Structure and Control of Highly Reliable System

In order to further improve the reliability of UPS, one can utilize a multiple unit structure system and an integrated management system with a load or computer device.

### 4.1 Current Spare System

This system is created by switching between two identical UPS units (current and spare). The current UPS stands by and is controlled to switch to the spare UPS without momentary power break when the current UPS is in trouble or repair. Generally, each UPS always uses the inverter method, and there is also a system that switches to the by-pass circuit without power break when both UPS units are down.

### 4.2 Bi-directional Spare System

This system uses the technology of bi-directional converter to maintain the same reliability as the current spare system while simplifying the spare machine.

In the structure shown in Fig.9, if there is any trouble with the forward direction converter or inversion converter, switching the converter to bi-directional converter as well as controlling the bi-directional converter in the forward direction or inversion converter enable continuous output supply without power break. We have promptly developed this system and manufactured for middle-range series of UPS.

### 4.3 Parallel Redundant System

Connecting the multiple numbers of UPS outputs in parallel creates a system with add-on capacity (N-method) that has output capacity for the number of units, or a highly reliable system that uses one unit as a spare (N+1 method).

Parallel running of AC, as shown in the equivalent circuit in Fig.11, loses balance because of mutual cross current if there is a difference between each voltage value. The vector direction of cross current against voltage is different by about 90 degrees depending on whether the voltage difference is a phase difference or an amplitude difference. A combination of load current and cross current flows in each

UPS and the control that balances this complex current is especially important.

As a balance control method, there is a cross current compensation that compares current for one machine with other machines to compensate in phase or amplitude. A common control is used to distribute a common control signal to each machine, and a master/slave control that distributes a control signal from a master machine regulates the cross currents. The former has a complex mutual control and signal line, and the latter relies on the reliability of the common control signal or the master machine.

Our middle-range UPS has a highly reliable system, which reduces the signal lines between other machines as much as possible by adopting the individual control method that adjusts the balance by looking at only its own inputs.

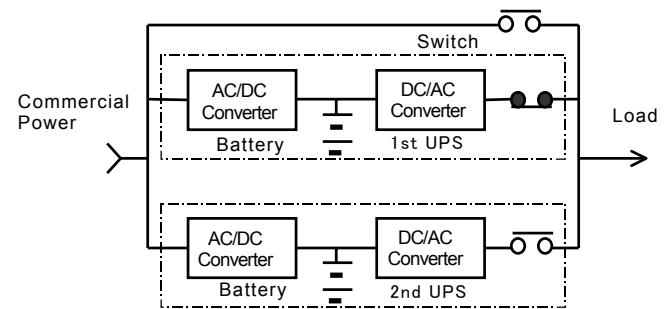

Fig.9 Structure of Current Spare System

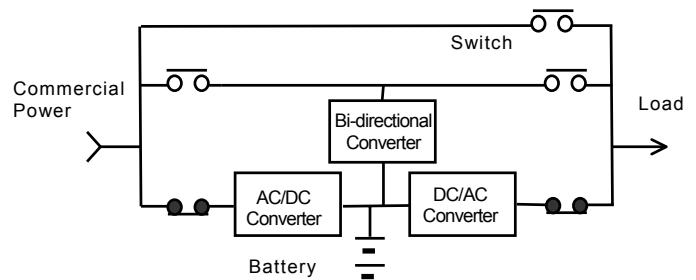

Fig.10 Structure of Bi-directional Spare System

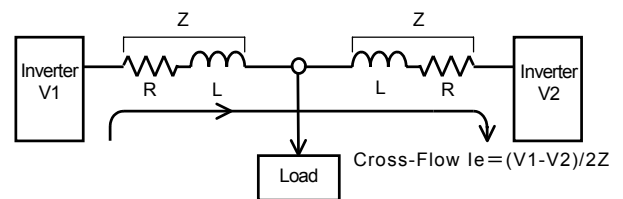

Fig.11 Equivalent Circuit When 2 Units in Parallel

### 4.4 UPS Control System

Various controls are available for the UPS thanks to the interface with the computer equipment that uses the UPS management software.

We have a simple product that shuts down the system without a problem upon power failure using a contact signal on the interface. We also have a high performance product that performs the scheduled operation and exchange of various control and information via the LAN interface resulting in reducing the burden of the network system administrator. The network environment is increasingly ex-

---

panding and developing over a wide range and we are working for the expansion and the development of the wide variety of management software to keep up with the trend.

## 5. Conclusion

---

When we first developed our static type UPS, it was an excellent start even though the output capacity was 1kVA and the size was large. Today, our 1kVA UPS is small enough that a single person can handle it. In addition, the features and the performances have improved dramatically. This progress is thanks to the continuous development of semiconductors, integrated circuits, microcomputers, and the control technology to use those devices.

However, the progress of the DC power supply devices represented by the switching regulator is remarkable not only in the computer field but also for the power supply field. We will keep working on the development of the UPS product that takes user needs and the global environment into account.



### **Satoru Shimizu**

Joined company in 1990  
Power Systems Division, 2nd Design Dept.  
Worked on the development of the static type power supply device



### **Muneo Suita**

Joined company in 1961  
Power Systems Division, 2nd Design Dept.  
Worked on the development of the static type power supply device